

### ADVANTAGES

- Hybrid - Ambiance fire or auxiliary heating
- 
- Versatile convection system
- 
- Can be connected to outside air
- 
- Accessible mechanical components
- 
- High heating power
- 
- Easy to light
- 
- Generates little ash
- 
- Minimalist design
- 
- Wide view of the fire
- 
- Easy to clean

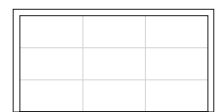
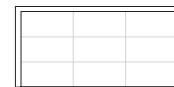
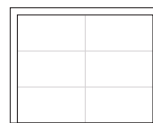
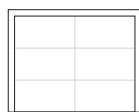

Size	21-85	21-95	21-105	21-125
Maximum length of logs	24"	28"	32"	40"
Maximum power (BTU)	48 000	55 000	48 000	60 000
Heating surface area	1 400 ft <sup>2</sup>	1 600 ft <sup>2</sup>	1 400 ft <sup>2</sup>	1 800 ft <sup>2</sup>
Firebox size	4.8 ft <sup>3</sup>	6.6 ft <sup>3</sup>	5.3 ft <sup>3</sup>	8.4 ft <sup>3</sup>
Weight	665 lb	820 lb	688 lb	892 lb
Outside air duct	ø 4-6"	ø 4-6"	ø 4-6"	ø 4-6"
Convection system	standard	standard	standard	standard
A - Width	39 11/16"	43 5/8"	47 9/16"	55 7/16"
B - Height	59"	63 3/8"	56 1/16"	59"
C - Depth	25 3/4"	27 7/8"	24 1/4"	26 7/8"
D - Glass width	26 3/8"	30 5/16"	34 1/4"	42 1/8"
E - Glass height	21 1/16"	24 3/16"	15 3/4"	21 1/16"
F - Opening width	30 3/4"	34 11/16"	38 11/16"	46 9/16"
G - Opening height	23 3/4"	26 7/8"	18 7/16"	23 3/4"
H - Chimney position	10 1/2"	11 13/16"	11 1/16"	11 3/4"
i - Chimney diameter	8"	*10"	8"	*10"
J - Height to opening	6 1/2"	6 1/2"	6 1/2"	6 1/2"
K - Width of floor protection	42 3/8"	46 5/16"	50 1/4"	58 1/8"

# Stûv 21 double face

## Technical sheet

**stûv**  
AMERICA

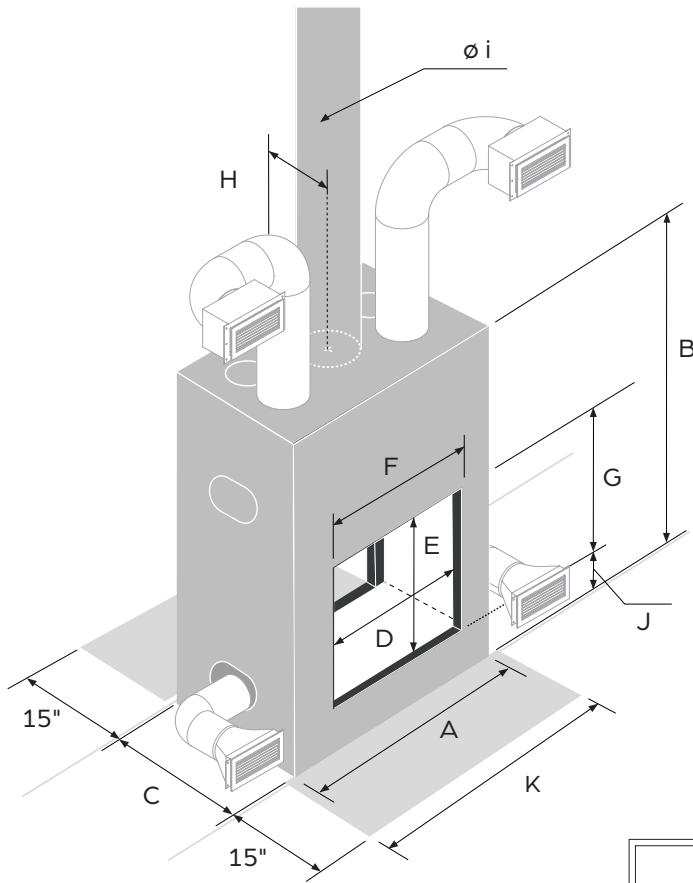

### ADVANTAGES

- Hybrid – Ambiance fire or auxiliary heating
- 
- Versatile convection system
- 
- Can be connected to outside air
- 
- Accessible mechanical components
- 
- High heating power
- 
- Easy to light
- 
- Generates little ash
- 
- Minimalist design
- 
- Wide view of the fire
- 
- Easy to clean

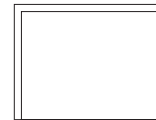
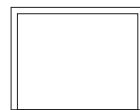

Size	21-85 DF	21-95 DF	21-125 DF
Maximum length of logs	24"	28"	40"
Maximum power (BTU)	48 000	55 000	60 000
Heating surface area	1 400 ft <sup>2</sup>	1 600 ft <sup>2</sup>	1 800 ft <sup>2</sup>
Firebox size	6.5 ft <sup>3</sup>	8.4 ft <sup>3</sup>	10.6 ft <sup>3</sup>
Weight	752 lb	855 lb	960 lb
Outside air duct	ø 6"	ø 6"	ø 6"
Convection system	standard	standard	standard
A – Width	39 11/16"	43 5/8"	55 7/16"
B – Height	58 3/4"	63 1/4"	58 3/4"
C – Depth	29 1/2"	29 1/2"	29 1/2"
D – Glass width	26 3/8"	30 5/16"	42 1/8"
E – Glass height	21 1/16"	24 3/16"	21 1/16"
F – Opening width	30 3/4"	34 11/16"	46 1/2"
G – Opening height	23 3/4"	26 7/8"	23 3/4"
H – Chimney position	14 3/4"	14 3/4"	14 3/4"
i – Chimney diameter	*10"	*12"	*12"
J – Height to opening	6 1/2"	6 1/2"	6 1/2"
K – Width of floor protection	42 3/8"	46 5/16"	58 1/8"

# FRAMES & FRONT PANELS



Thin edge	21-85	21-95	21-105	21-125
W	31 <sup>5</sup> / <sub>8</sub> "	35 <sup>3</sup> / <sub>16</sub> "	39 <sup>1</sup> / <sub>8</sub> "	47"
H	24 <sup>1</sup> / <sub>8</sub> "	27 <sup>1</sup> / <sub>4</sub> "	18 <sup>13</sup> / <sub>16</sub> "	24 <sup>1</sup> / <sub>8</sub> "

● StûvGrey only

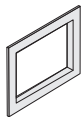

Picture type	21-85	21-95	21-105	21-125
W	35 <sup>5</sup> / <sub>8</sub> "	39 <sup>5</sup> / <sub>8</sub> "	43 <sup>1</sup> / <sub>2</sub> "	51 <sup>3</sup> / <sub>8</sub> "
H	28 <sup>1</sup> / <sub>2</sub> "	31 <sup>5</sup> / <sub>8</sub> "	23 <sup>1</sup> / <sub>4</sub> "	28 <sup>1</sup> / <sub>2</sub> "

● StûvGrey only

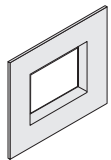

SF4	21-85	21-95	21-105	21-125
W	49 <sup>3</sup> / <sub>4</sub> "	53 <sup>3</sup> / <sub>4</sub> "	57 <sup>5</sup> / <sub>8</sub> "	65 <sup>1</sup> / <sub>2</sub> "
H	42 <sup>5</sup> / <sub>8</sub> "	45 <sup>3</sup> / <sub>4</sub> "	37 <sup>3</sup> / <sub>8</sub> "	42 <sup>5</sup> / <sub>8</sub> "

● ○ ● ● ●

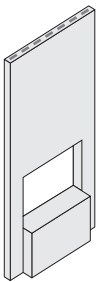

SF5	21-85 SF	21-95	21-105	21-125
W	42 <sup>5</sup> / <sub>8</sub> "	46 <sup>5</sup> / <sub>8</sub> "	50 <sup>1</sup> / <sub>2</sub> "	58 <sup>1</sup> / <sub>2</sub> "
H	78 <sup>3</sup> / <sub>4</sub> "	86"	78 <sup>3</sup> / <sub>4</sub> "	78 <sup>3</sup> / <sub>4</sub> "

● ○ ● ● ●

Integrated convection system

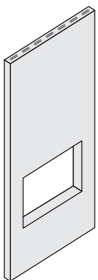

SF6	21-85	21-95	21-105	21-125
W	42 <sup>5</sup> / <sub>8</sub> "	46 <sup>5</sup> / <sub>8</sub> "	-	58 <sup>1</sup> / <sub>2</sub> "
H	78 <sup>3</sup> / <sub>4</sub> "	86"	-	78 <sup>3</sup> / <sub>4</sub> "

● ○ ● ● ●

Integrated convection system

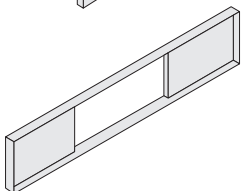

SF8	21-85	21-95	21-105	21-125
W	-	-	94 <sup>1</sup> / <sub>2</sub> "	-
H	-	-	18 <sup>7</sup> / <sub>8</sub> "	-

● StûvGrey only

Outer dimensions W = Width | H = Height

Dimensions indicated are for informative purposes only. For more details see installation manual.