

Stûv 21

Fiche technique

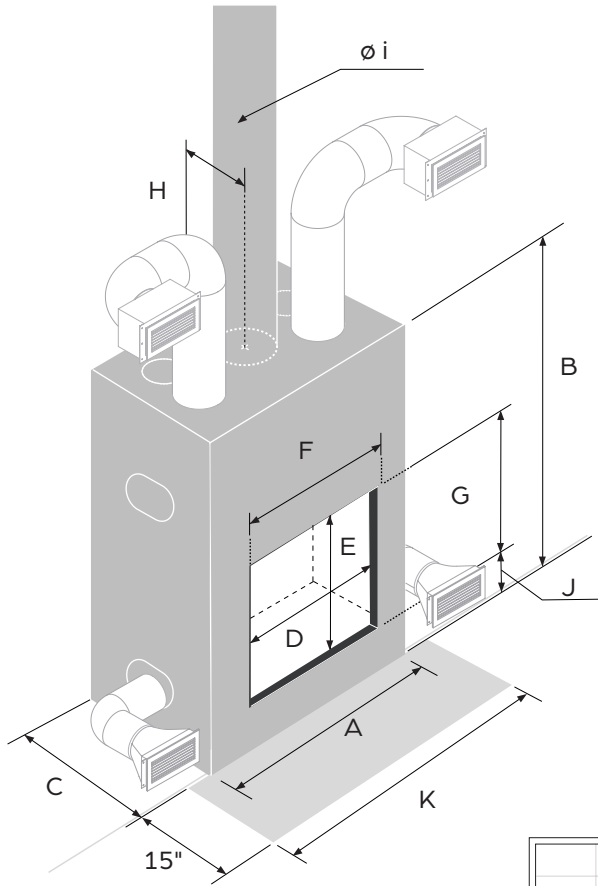

AVANTAGES

- Hybride
- Feu ambiant ou chauffage d'appoint
- Système de convection modulable de série
- Possibilité de raccordement à l'air extérieur
- Composants mécaniques accessibles
- Grande puissance de chauffe
- Simple à allumer
- Génère peu de cendres
- Design minimaliste
- Grande vue sur le feu
- Facile d'entretien

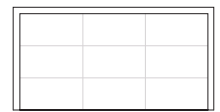
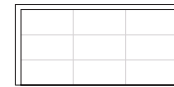

Format	21-85	21-95	21-105	21-125
Longueur max. des bûches	24"	28"	32"	40"
Puissance maximale (BTU)	48 000	55 000	48 000	60 000
Superficie de chauffage	1 400 pi ²	1 600 pi ²	1 400 pi ²	1 800 pi ²
Chambre de combustion	4.8 pi ³	6.6 pi ³	5.3 pi ³	8.4 pi ³
Poids	665 lb	820 lb	688 lb	892 lb
Raccordement air extérieur	ø 4-6"	ø 4-6"	ø 4-6"	ø 4-6"
Système de convection	standard	standard	standard	standard
A - Largeur	39 11/16"	43 5/8"	47 9/16"	55 7/16"
B - Hauteur	59"	63 3/8"	56 1/16"	59"
C - Profondeur	25 3/4"	27 7/8"	24 1/4"	26 7/8"
D - Largeur vitre	26 3/8"	30 5/16"	34 1/4"	42 1/8"
E - Hauteur vitre	21 1/16"	24 3/16"	15 3/4"	21 1/16"
F - Largeur ouverture	30 3/4"	34 11/16"	38 11/16"	46 9/16"
G - Hauteur ouverture	23 3/4"	26 7/8"	18 7/16"	23 3/4"
H - Position cheminée	10 1/2"	11 13/16"	11 1/16"	11 3/4"
i - Diamètre cheminée	8"	*10"	8"	*10"
J - Niveau ouverture	6 1/2"	6 1/2"	6 1/2"	6 1/2"
K - Largeur protection sol	42 3/8"	46 5/16"	50 1/4"	58 1/8"

Stûv 21 double face

Fiche technique

stûv
AMERICA

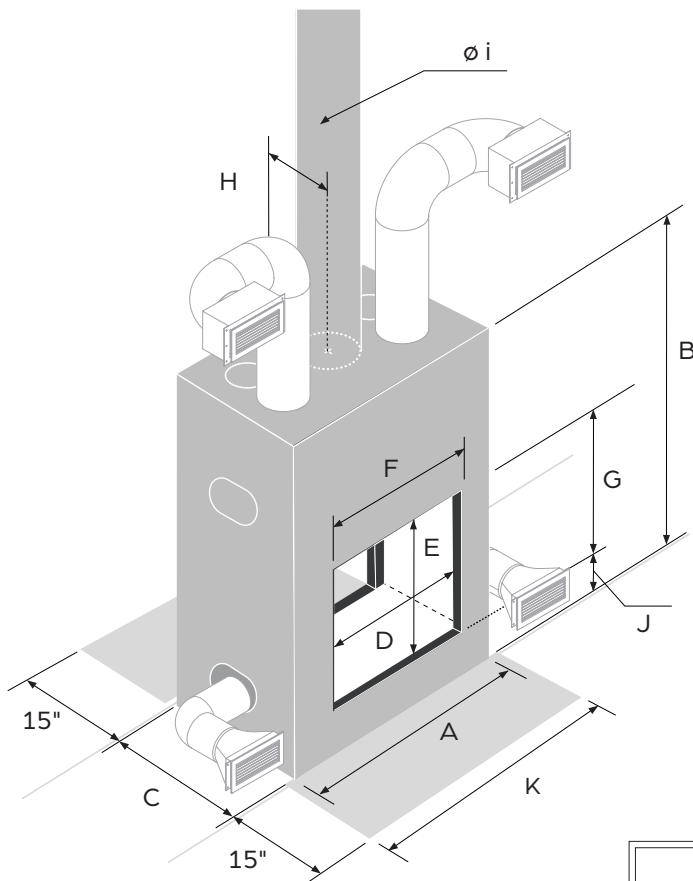

AVANTAGES

- Hybride : Feu ambiant ou chauffage d'appoint
-
- Système de convection modulable de série
-
- Possibilité de raccordement à l'air extérieur
-
- Composants mécaniques accessibles
-
- Grande puissance de chauffe
-
- Simple à allumer
-
- Génère peu de cendres
-
- Design minimaliste
-
- Grande vue sur le feu
-
- Facile d'entretien

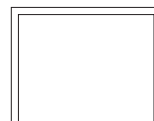

Format	21-85 DF	21-95 DF	21-125 DF
Longueur max. des bûches	24"	28"	40"
Puissance maximale (BTU)	48 000	55 000	60 000
Superficie de chauffage	1 400 pi ²	1 600 pi ²	1 800 pi ²
Chambre de combustion	6.5 pi ³	8.4 pi ³	10.6 pi ³
Poids	752 lb	855 lb	960 lb
Raccordement air extérieur	ø 6"	ø 6"	ø 6"
Système de convection	standard	standard	standard
A - Largeur	39 11/16"	43 5/8"	55 7/16"
B - Hauteur	58 3/4"	63 1/4"	58 3/4"
C - Profondeur	29 1/2"	29 1/2"	29 1/2"
D - Largeur vitre	26 3/8"	30 5/16"	42 1/8"
E - Hauteur vitre	21 1/16"	24 3/16"	21 1/16"
F - Largeur ouverture	30 3/4"	34 11/16"	46 1/2"
G - Hauteur ouverture	23 3/4"	26 7/8"	23 3/4"
H - Position cheminée	14 3/4"	14 3/4"	14 3/4"
i - Diamètre cheminée	*10"	*12"	*12"
J - Niveau ouverture	6 1/2"	6 1/2"	6 1/2"
K - Largeur protection sol	42 3/8"	46 5/16"	58 1/8"

CADRES & DEVANTURES



fin	21-85	21-95	21-105	21-125
L	31 5/8"	35 3/16"	39 1/8"	47"
H	24 1/8"	27 1/4"	18 13/16"	24 1/8"

● StûvGrey uniquement

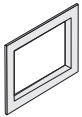

appliqué	21-85	21-95	21-105	21-125
L	35 5/8"	39 5/8"	43 1/2"	51 3/8"
H	28 1/2"	31 5/8"	23 1/4"	28 1/2"

● StûvGrey uniquement

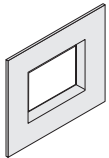

SF4	21-85	21-95	21-105	21-125
L	49 3/4"	53 3/4"	57 5/8"	65 1/2"
H	42 5/8"	45 3/4"	37 3/8"	42 5/8"

● ○ ● ● ●

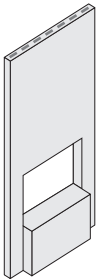

SF5	21-85 SF	21-95	21-105	21-125
L	42 5/8"	46 5/8"	50 1/2"	58 1/2"
H	78 3/4"	86"	78 3/4"	78 3/4"

● ○ ● ● ●

Système de convection intégré

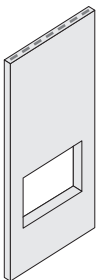

SF6	21-85	21-95	21-105	21-125
L	42 5/8"	46 5/8"	-	58 1/2"
H	78 3/4"	86"	-	78 3/4"

● ○ ● ● ●

Système de convection intégré

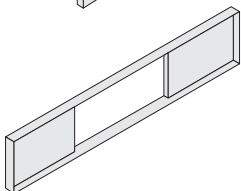

SF8	21-85	21-95	21-105	21-125
L	-	-	94 1/2"	-
H	-	-	18 7/8"	-

● StûvGrey uniquement