

Stûv 21-clad SF2

Technical sheet

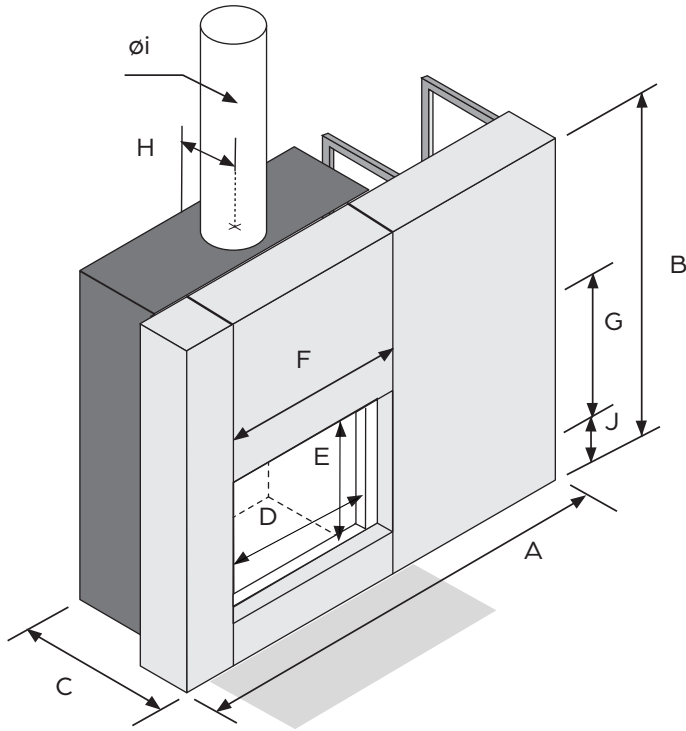

ADVANTAGES

- Quick and easy installation
-
- Hybrid - Ambiance fire or auxiliary heating
-
- Integrated convection system
-
- Can be connected to outside air
-
- Accessible mechanical components
-
- High heating power
-
- Easy to light
-
- Generates little ash
-
- No finishing work required
-
- Wide view of the fire
-
- Easy to maintain

Available colors



* Approximate weight includes fireplace and cladding

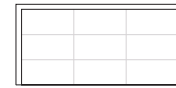
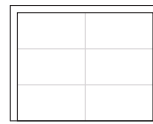
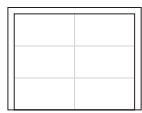

Size	21-85 SF	21-95 SF	21-105 SF	21-125 SF
Maximum length of logs	24"	28"	32"	40"
Maximum power (BTU)	48 000	55 000	48 000	60 000
Heating surface area	1 400 ft ²	1 600 ft ²	1 400 ft ²	1 800 ft ²
Firebox size	4.8 ft ³	6.6 ft ³	5.3 ft ³	8.4 ft ³
Outside air duct	ø 4-6"	ø 4-6"	ø 4-6"	ø 4-6"
Floor protection	42 ³ / ₈ " x 13 ³ / ₁₆ "	46 ⁵ / ₁₆ " x 13 ³ / ₁₆ "	50 ¹ / ₄ " x 13 ³ / ₁₆ "	58 ¹ / ₈ " x 13 ³ / ₁₆ "
Weight*	775 lb	925 lb	765 lb	975 lb
A - Width	66 ⁵ / ₁₆ "	70 ¹ / ₄ "	74 ³ / ₁₆ "	82 ¹ / ₁₆ "
B - Height	59 ⁵ / ₈ "	64 ¹ / ₄ "	51 ⁷ / ₁₆ "	59 ⁵ / ₈ "
C - Depth	27 ⁷ / ₁₆ "	29 ⁷ / ₁₆ "	25 ¹ / ₂ "	28 ¹ / ₄ "
D - Glass width	26 ³ / ₈ "	30 ⁵ / ₁₆ "	34 ¹ / ₄ "	42 ¹ / ₈ "
E - Glass height	21 ¹ / ₁₆ "	24 ³ / ₁₆ "	15 ³ / ₄ "	21 ¹ / ₁₆ "
F - Opening width	30 ⁷ / ₈ "	34 ¹³ / ₁₆ "	38 ³ / ₄ "	46 ⁵ / ₈ "
G - Opening height	23 ³ / ₄ "	26 ⁷ / ₈ "	18 ⁷ / ₁₆ "	23 ³ / ₄ "
H - Chimney position	11 ⁵ / ₈ "	12 ¹ / ₂ "	11 ³ / ₈ "	12 ⁵ / ₁₆ "
i - Chimney diameter	8"	*10"	8"	*10"
J - Height to opening	12 ³ / ₄ "	12 ³ / ₄ "	12 ³ / ₄ "	12 ³ / ₄ "

LOG RACKS

FINISHING ACCESSORIES

WARNING: The log racks are **NOT** equipped with wheels and **are sold separately**.

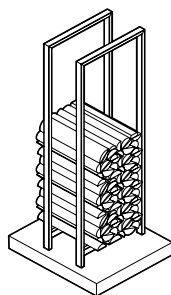

SF2 log rack
21-85 clad, 21-95 clad et 21-125 clad
17 $\frac{3}{16}$ " W x 58 $\frac{3}{16}$ " H x 19 $\frac{11}{16}$ " D

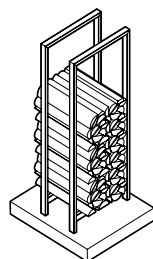

SF2 log rack
21-105 clad
15 $\frac{3}{8}$ " W x 52 $\frac{9}{16}$ " H x 19 $\frac{11}{16}$ " D

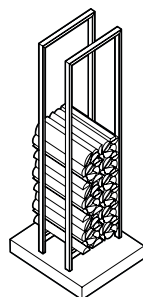

DF2 / DF7 log rack
21-85 clad DF, 21-95 clad DF et 21-125 clad DF
13 $\frac{3}{8}$ " W x 58 $\frac{3}{16}$ " H x 19 $\frac{11}{16}$ " D

AVAILABLE COLORS



StûvGrey



StûvBlack



Rust